

CENIK PREZRAČEVANJA 2026

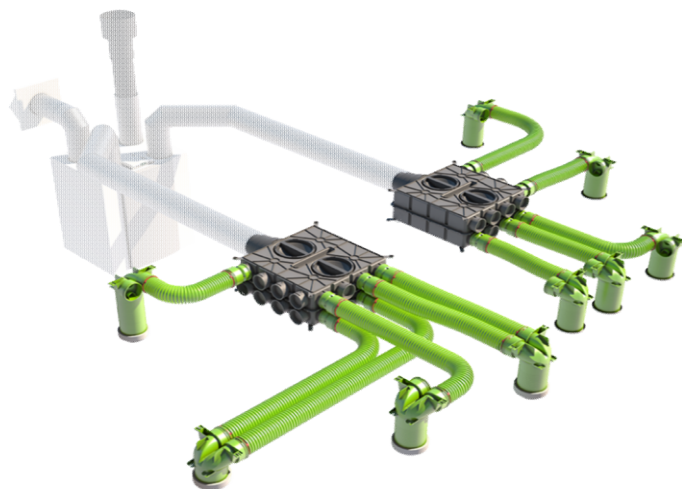

Živite bolj zdravo

Prezračevalni sistemi BRINK in UBBINK

Certifikati



Podatkovni listi

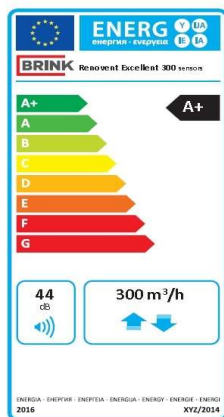

Za prezračevalni sistem dobite nepovratna sredstva s strani Eko sklada



KAZALO

	stran
Lokalna prezračevalna naprava Air 70	4
	
Prezračevalne naprave EASE, SKY, Brink Flair	5-11
	
Garancijski zagon prezračevalne naprave Brink Renovent	12
	
Dodatki za prezračevalne naprave Brink	13-14
	
Elementi za zajem svežega in odpadnega zraka	15-16
	
Vlaženje, filtracija,	17
	
Pohlajevanje in dogrevanje	18-19
	
Komore	20-22
	
Air Excellent	23-25
	
Distribucijski elementi	27
	

LOKALNA PREZRAČEVALNA NAPRAVA AIR 70

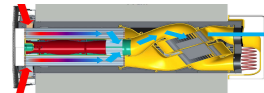

Naziv	Opis	Koda	Cena	
			Zunanja rešetka - bela RAL 9010	Zunanja rešetka - nerjaveče jeklo
AIR70 lokalni rekuperator	Zmogljivost: 70 m ³ /h, tiha in nizkoenergijska naprava z bypassom, predgrelnikom, prikazovalnikom pretoka zraka na napravi, enostavna montaža, garancija 24 mesecev. Izkoristek rekuperacije po EN 13141-8 znaša 79%.	koda	BR450050	BR450052
		cena	1.460,40	1.512,90
AIR70 Plus lokalni rekuperator	Zmogljivost: 70 m ³ /h, tiha in nizkoenergijska naprava z bypassom, predgrelnikom, prikazovalnikom pretoka zraka na napravi, enostavna montaža, plus verzija, ki omogoča dodaten priklop CO2 senzorja, senzorja vlage, stikala za vklop in izklop, garancija 24 mesecev. Izkoristek rekuperacije po EN 13141-8 znaša 79%.	koda	BR450051	BR450053
		cena	1.549,70	1.591,70

Podaljševalne cevi za lokalni rekuperator AIR 70

	za steno debeline 600-700	koda	BR600-700	
		cena	328,10	
Ohišje fasadne rešetke 	za steno debeline 550-600 mm		element ni potreben	
	za steno debeline 450-500mm	koda	BR451050	BR452050
		cena	115,30	164,70
	za steno debeline 400-450mm	koda	BR451051	BR452051
		cena	115,30	164,70
	za steno debeline 350-400mm	koda	BR451052	BR452052
		cena	115,30	164,70
	za steno debeline 300-350mm	koda	BR451053	BR452053
		cena	115,30	164,70
	za steno debeline 270-300mm	koda	BR451054	BR452054
		cena	115,30	164,70

Dodatki za lokalni rekuperator AIR 70 - samo PLUS verzija

	Koda	Cena
CO2 senzor s kablom	BR450101	332,30
Senzor vlage s kablom	BR450102	231,20
Brink Home Set	BR450103	372,80
4-stopenjsko stensko stikalo	BR540262	111,90

Filtri za lokalni rekuperator AIR70

Filter komplet	2 x G4 in 1 x F7	BR450109	73,40
Filter komplet	3 x G4	BR536006	31,50





Notranja rešetka 38x38cm

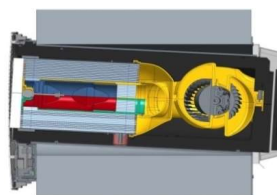

Zunanja rešetka 30x36cm



PREZRAČEVALNE NAPRAVE BRINK EASE

EASE 200		Orientacija	4/0 desni	4/0 levi
 <p>EKO SKLAD SLOVENSKI OKOLJSKI JAVNI SKLAD</p>		teža (Š x V x G) Priključki	17 kg 560 x 660 x 315 mm Ø 125 mm	
Maks. pretok zraka 200m ³ /h pri 200Pa, rekuperacija 92% (Ecodesign ErP), 87% (PHI). Vključuje 100% obvod – avt., PETG prenosnik, sifon. 5-letna garancija s petimi kompleti filtrov.		koda (PETG-standard)	BR433101	BR433100
		cena	2.306,30	2.306,30
		* koda (ERV-entalpija)	BR433109	BR433108
		cena	2.813,70	2.813,70

ORIENTACIJE PREZRAČEVALNE NAPRAVE BRINK EASE 200

EASE 200

Leva izvedba

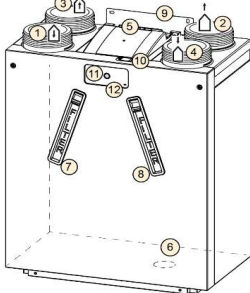

Desna izvedba

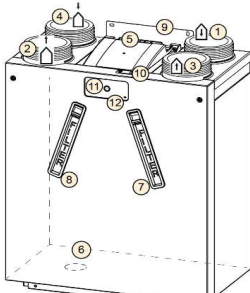

1	Dovodni zrak	↑
2	Izpušni zrak	↑
3	Izhodni zrak	↑
4	Zunanji zrak	↓
5	Električni priključki tiskanega vezja	
6	Priključek sifona	
7	Filter izpušnega zraka	
8	Filter za dovodni zrak	
9	Montažni nosilec	
10	Priključek USB in servisnega orodja	
11	Tipka	
12	LED za stanje	

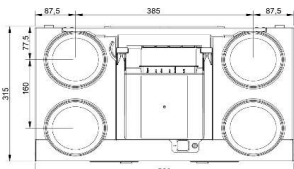

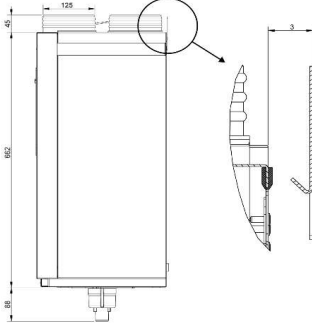







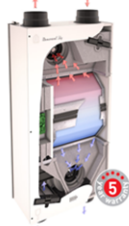





5-letna garancija

PREZRAČEVALNE NAPRAVE BRINK RENOVENT

RENOVENT SKY 150 - PETG		Orientacija	standard
 <p style="font-size: small; margin: 0;">EKO SKLAD SLOVENSKE OKOLJSKE JAVNE AGENCIJE</p>	 	teža (GxŠxD) priklučki	24,5 kg 198 x 660 x 1000 ø 125 mm
Maks. pretok zraka 150m ³ /h, stropna/stenska montaža, 100% obvod zraka - avt., PETG prenosnik, vgrajen predgrelnik. Krmilnik in sifon nista vključena. 5-letna garancija s petimi kompleti filtrov. 83% izkoristek po Eco design in EN13141-7		koda (standard)	BR423000
		cena	2.607,60
		* * koda (ERV-entalpija)	BR423042
		cena	2.921,30
		  5-letna garancija	
RENOVENT SKY 150 PLUS - PETG		Orientacija	standard
 <p style="font-size: small; margin: 0;">EKO SKLAD SLOVENSKE OKOLJSKE JAVNE AGENCIJE</p>	 	teža (GxŠxD) priklučki	24,5 kg 198 x 660 x 1000 ø 125 mm
Maks. pretok zraka 150m ³ /h, stropna/stenska montaža, 100% obvod zraka - avt., PETG prenosnik, vgrajen predgrelnik. Verzija plus omogoča priklučitev dodatne opreme. Krmilnik in sifon nista vključena. 5-letna garancija s petimi kompleti filtrov. 83% izkoristek po Eco design in EN 13141-7.		koda (standard)	BR423001
		cena	2.921,30
		* * koda (ERV-entalpija)	BR423043
		cena	3.524,00
		  5-letna garancija	
RENOVENT SKY 200 - PETG		Orientacija	standard
 <p style="font-size: small; margin: 0;">EKO SKLAD SLOVENSKE OKOLJSKE JAVNE AGENCIJE</p>	 	teža (GxŠxD) priklučki	24,5 kg 198 x 660 x 1000 ø 160 mm
Maks. pretok zraka 200m ³ /h, stropna/stenska montaža, 100% obvod - avt., PETG prenosnik, vgrajen predgrelnik. Krmilnik in sifon nista vključena. 5-letna garancija s petimi kompleti filtrov. 83% izkoristek po Eco design in EN13141-7		koda (standard)	BR424000
		cena	2.729,60
		* * koda (ERV-entalpija)	BR424016
		cena	3.038,10
		  5-letna garancija	

RENOVENT SKY 200 PLUS - PETG		Orientacija	standard
 <p>EKO SKLAD SLOVENSKE OKOLJSKI JAVNI SKLAD</p> <p>Maks. pretok zraka 200m³/h, stropna/stenska montaža, 100% obvod zraka – avt., PETG prenosnik, vgrajen predgrelnik. Verzija plus omogoča priključitev dodatne opreme. Krmilnik in sifon nista vključena. 5-letna garancija s petimi kompleti filtrov. 83% izkoristek po Eco design in EN 13141-7.</p>		teža (GxŠxD) priključki	24,5 kg 198 x 660 x 1000 ø 160 mm
		koda (standard)	BR424001
		cena	3.038,50
		* * koda (ERV-entalpija)	BR424017
		cena	3.659,30
		  5-letna garancija	
RENOVENT SKY 300 - PETG		Orientacija	standard
 <p>EKO SKLAD SLOVENSKE OKOLJSKI JAVNI SKLAD</p> <p>Maks. pretok zraka 300m³/h, stropna/stenska montaža, 100% obvod zraka - avt., PETG prenosnik. Predgrelnik, krmilnik in sifon niso vključeni. 5-letna garancija s petimi kompleti filtrov. 84% izkoristek po Eco design in EN 13141-7.</p>		teža (GxŠxD) priključki	37 kg 310 x 664 x 1185 ø 150 mm ø 160 mm
		koda (standard)	BR422004
		cena	2.792,60
		* koda (ERV-entalpija)	BR422030
		cena	3.719,30
		  5-letna garancija	
RENOVENT SKY 300 PLUS - PETG		Orientacija	standard
 <p>EKO SKLAD SLOVENSKE OKOLJSKI JAVNI SKLAD</p> <p>Maks. pretok zraka 300m³/h, stropna/stenska montaža, 100% obvod zraka – avt., PETG prenosnik. Verzija plus omogoča priključitev dodatne opreme. Predgrelnik, krmilnik in sifon niso vključeni. 5-letna garancija s petimi kompleti filtrov. 84% izkoristek po Eco design in EN 13141-7.</p>		teža (GxŠxD) priključki	37 kg 310 x 664 x 1185 ø 150 mm ø 160 mm
		koda (standard)	BR422005
		cena	3.101,50
		* koda (ERV-entalpija)	BR422031
		cena	4.028,10
		  5-letna garancija	

* element ni na zalogi, dobavljivo po naročilu, predhodno je potrebno preveriti rok dobave

* naprava brez predgrelnika svežega zraka

ORIENTACIJE PREZRAČEVALNE NAPRAVE RENOVENT SKY

RENOVENT SKY 150 in 200

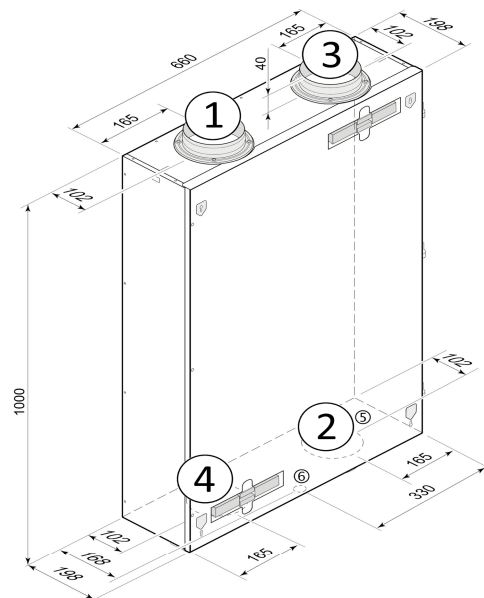

Za stensko in stropno montažo



- 1. V PROSTOR 
- 2. V OKOLJE 
- 3. IZ PROSTORA 
- 4. IZ OKOLICE 
- 5. ELEKTRIČNA POVEZAVA
- 6. KONDENZ

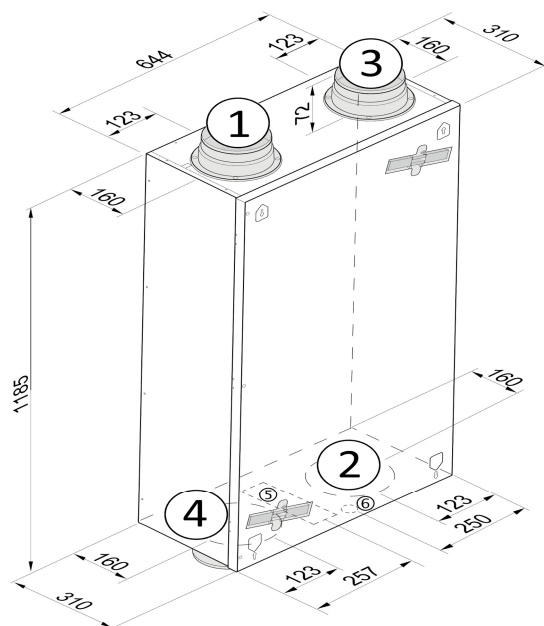

RENOVENT SKY 300



PREZRAČEVALNE NAPRAVE BRINK FLAIR

FLAIR 225		Orientacija	4/0 desni	4/0 levi
 <p>EKO SKLAD SLOVENSKI OKOLJSKI JAVNI SKLAD</p> <p>Maks. pretok zraka 225m³/h pri 250Pa, rekuperacija 92% (Ecodesign ErP), 89% (PHI). Vključuje 100% obvod – avt., PETG prenosnik, predgrelnik, sifon, vgrajen krmilnik na dotik. 5-letna garancija s petimi kompleti filtrov.</p>		teža (Š x V x G) Priključki	35 kg 600 x 650 x 455 mm Ø 125 mm	
		koda (PETG-standard)	BR428001	BR428000
		cena	2.913,70	2.913,70
		* koda (ERV-entalpija)	BR428011	BR428010
		cena	3.653,10	3.653,10

FLAIR 325		Orientacija	4/0 desni	2/2 desni	4/0 levi	2/2 levi
 <p>EKO SKLAD SLOVENSKI OKOLJSKI JAVNI SKLAD</p> <p>Maks. pretok zraka 325m³/h pri 250Pa. - rekuperacija PETG izmenjevalca 92,5% (Ecodesign ErP), 91% (PHI) - rekuperacija ERV (entalpijski) izmenjevalca 83% (Ecodesign ErP), 86% (PHI). Vključuje 100% obvod – avt., PETG prenosnik, predgrelnik, sifon, vgrajen krmilnik na dotik. 5-letna garancija s petimi kompleti filtrov.</p>		teža (Š x V x G) Priključki	37 kg 750 x 650 x 560 mm Ø 160 mm			
		koda (PETG-standard)	BR430001	BR430101	BR430000	BR430100
		cena	3.295,10	3.295,10	3.295,10	3.295,10
		* koda (ERV-entalpija)	BR430013		BR430012	
		cena	4.164,20		4.164,20	

FLAIR 400		Orientacija	4/0 desni	2/2 desni	4/0 levi	2/2 levi
 <p>EKO SKLAD SLOVENSKI OKOLJSKI JAVNI SKLAD</p> <p>Maks. pretok zraka 400m³/h pri 270Pa. - rekuperacija PETG izmenjevalca 92% (Ecodesign ErP), 89% (PHI) - rekuperacija ERV (entalpijski) izmenjevalca 81% (Ecodesign ErP), 84% (PHI). Vključuje 100% obvod – avt., PETG prenosnik, predgrelnik, sifon, vgrajen krmilnik na dotik. 5-letna garancija s petimi kompleti filtrov.</p>		teža (Š x V x G) Priključki	37 kg 750 x 650 x 560 mm Ø 180 mm			
		koda (PETG-standard)	BR431001	BR431101	BR431000	BR431100
		cena	3.551,50	3.551,50	3.551,50	3.551,50
		* koda (ERV-entalpija)	BR431033		BR431032	
		cena	4.420,60		4.420,60	

Če želite na napravo Flair 325/400 priključiti dodatno opremo potrebujete Priključni Box, ki ga najdete pod dodatki za naprave.

*PHI - Passive House Institute

* element ni na zalogi, dobavljivo po naročilu, predhodno je potrebno preveriti rok dobave



5-letna garancija

FLAIR 450		Orientacija	4/0 desni	4/0 levi
 <p>EKO SKLAD SLOVENSKI OKOLJSKI JAVNI SKLAD</p> <p>Maks. pretok zraka 450m³/h pri 200Pa, rekuperacija 92% (Ecodesign ErP), 92% (PHI). Vključuje 100% obvod – avt., PETG prenosnik, predgrelnik, sifon, vgrajen krmilnik na dotik. 5-letna garancija s petimi kompleti filtrov.</p>		teža (Š x V x G) Priključki	53kg 800 x 661 mm Ø 200 mm	
		koda (PETG-standard)	BR432001	BR432000
		cena	4.514,40	4.514,40
		* koda (ERV-entalpija)	BR432009	BR432008
		cena	5.446,00	5.446,00

FLAIR 600		Orientacija	4/0 desni	4/0 levi
 <p>EKO SKLAD SLOVENSKI OKOLJSKI JAVNI SKLAD</p> <p>Maks. pretok zraka 600m³/h pri 190Pa, rekuperacija 92% (Ecodesign ErP), 90% (PHI). Vključuje 100% obvod – avt., PETG prenosnik, predgrelnik, sifon, vgrajen krmilnik na dotik. 5-letna garancija s petimi kompleti filtrov.</p>		teža (Š x V x G) Priključki	53kg 800 x 850 x 661 mm Ø 200 mm	
		koda (PETG-standard)	BR433001	BR433000
		cena	5.107,90	5.107,90
		* koda (ERV-entalpija)	BR433003	BR433002
		cena	5.960,20	5.960,20

Če želite na napravo Flair 325/400 priključiti dodatno opremo potrebujete Priključni Box, ki ga najdete pod dodatki za naprave.

*PHI - Passive House Institute

BRINK

 5-letna garancija

ORIENTACIJE PREZRAČEVALNE NAPRAVE FLAIR

Flair 225

Desna različica

4/0

Leva različica

4/0

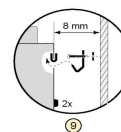
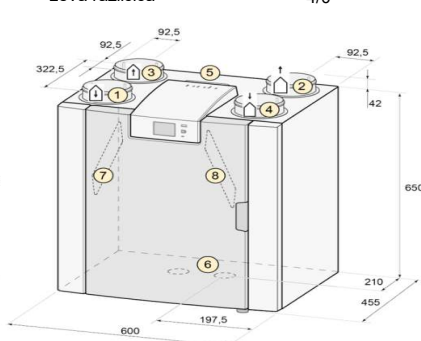
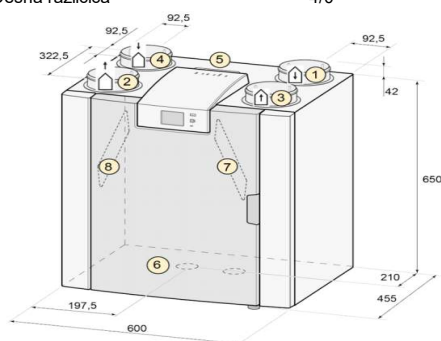

1. V PROSTOR 
2. V OKOLJE 
3. IZ PROSTORA 
4. IZ OKOLICE 
5. ELEKTRIČNA POVEZAVA
6. KONDENZ

Flair 325/400

Desna različica

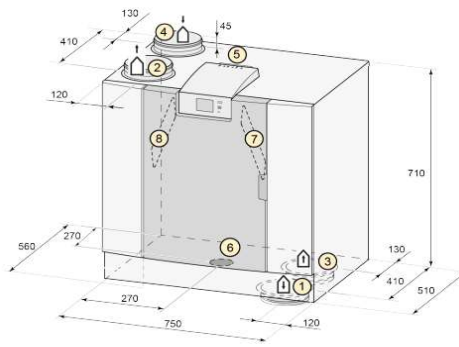
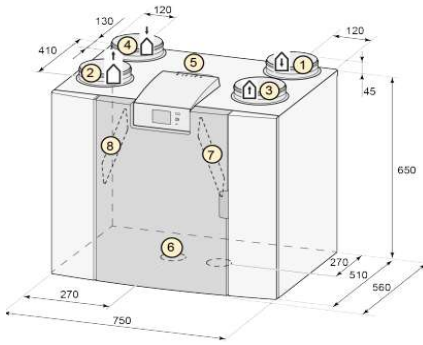

- 1. V PROSTOR
- 2. V OKOLJE
- 3. IZ PROSTORA
- 4. IZ OKOLICE
- 5. ELEKTRIČNA POVEZAVA
- 6. KONDENZ

Leva različica

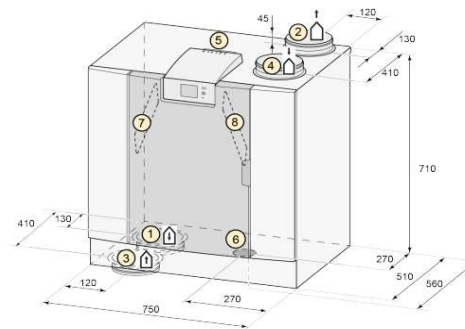
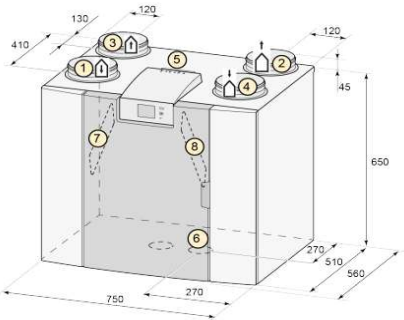

Flair 450/600

Leva različica

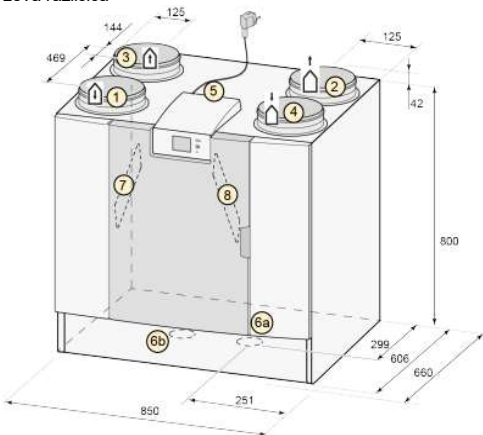

Desna različica

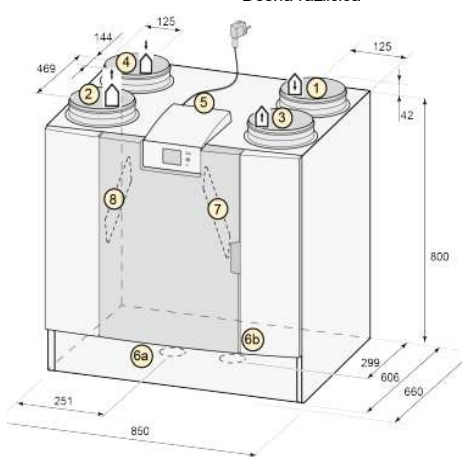

- 1. V PROSTOR
- 2. V OKOLJE
- 3. IZ PROSTORA
- 4. IZ OKOLICE
- 5. ELEKTRIČNA POVEZAVA
- 6. KONDENZ



GARANCIJSKI ZAGON PREZRAČEVALNE NAPRAVE BRINK RENOVENT, FLAIR

Koda	Naziv	Cena
STZAREN	Zagon prezračevalne naprave Brink	150,00

Električne povezave za napravo: povezavo za regulator in dovod električne energije pripravi investitor pred izvedbo zagona.

V garancijskem zagonu rekuperatorja je zajeto:

- enkratni obisk serviserja na objektu,
- montaža in povezava regulatorja z rekuperatorjem na pred-pripravljeno električno inštalacijo,
- električni priklop naprave na pred-pripravljeno električno inštalacijo,
- prvi vklop in nastavitev parametrov naprave,
- potni in prevozni stroški do 60 km.

Podatki za izvedbo povezav:

- za stenski upravljalnik:

1. 4-stopenjsko stikalo: kabel UTP CAT5 4x2x0.6mm2 od lokacije PODOMETNEGA stikala do naprave, pripraviti podometno dozo z vodoravno postavitvijo vijakov z razmakom 60 mm (primer sm 60-06) na predvideni lokaciji;
ALI

2. stenski žični daljinski upravljalnik Brink Air Control s prikazovalnikom: presek žice za povezavo stenskega daljinskega upravljalnika in rekuperatorja najmanj 2 x 0,34 mm2 in ne več kot 0,75 mm2, potrebo pripraviti podometno dozo z vodoravno postavitvijo vijakov z razmakom 60 mm (primer sm 60-06)

- za rekuperator: 2x vtičnica 230V ob napravi (priključni kabel s šuko vtikačem na napravi je dolžine 1m)
(1 x rekuperator, 1 x servisna vtičnica, v kolikor so prisotni še drugi dodatki se pripravi ustrezno število vtičnic)

Montažo elektro instalacij v celoti izvede naročnik.

V ceni zajeti potni in transportni stroški do 60 km (gledano obe smeri).

Koda	Naziv	Cena
STZANREN	Zagon prezračevalne naprave Brink z meritvijo količin zraka	250,00

Električne povezave za napravo: povezavo za regulator in dovod električne energije pripravi investitor pred izvedbo zagona.

V garancijskem zagonu rekuperatorja je zajeto:

- enkratni obisk serviserja na objektu,
- montaža in povezava regulatorja z rekuperatorjem na pred-pripravljeno električno inštalacijo,
- električni priklop naprave na pred-pripravljeno električno inštalacijo,
- prvi vklop in nastavitev parametrov naprave,
- potni in prevozni stroški do 60 km.

- **nastavitev količin zraka**

Podatki za izvedbo povezav:

- za stenski upravljalnik:

1. 4-stopenjsko stikalo: kabel UTP CAT5 4x2x0.6mm2 od lokacije PODOMETNEGA stikala do naprave, pripraviti podometno dozo z vodoravno postavitvijo vijakov z razmakom 60 mm (primer sm 60-06) na predvideni lokaciji;
ALI











2. stenski žični daljinski upravljalnik Brink Air Control s prikazovalnikom: presek žice za povezavo stenskega daljinskega upravljalnika in rekuperatorja najmanj 2 x 0,34 mm2 in ne več kot 0,75 mm2, potrebo pripraviti podometno dozo z vodoravno postavitvijo vijakov z razmakom 60 mm (primer sm 60-06)

- za rekuperator: 2x vtičnica 230V ob napravi (priključni kabel s šuko vtikačem na napravi je dolžine 1m)
(1 x rekuperator, 1 x servisna vtičnica, v kolikor so prisotni še drugi dodatki se pripravi ustrezno število vtičnic)

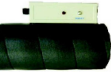
Montažo elektro instalacij v celoti izvede naročnik.

V ceni zajeti potni in transportni stroški do 60 km (gledano obe smeri).

DODATKI ZA PREZRAČEVALNE NAPRAVE BRINK

Naziv	Slika		EASE 200	Flair 225 DN125	Flair 325 DN160	Flair 400 DN180	Flair 450/600 DN200
4-stopenjsko stensko stikalo z indikacijo stanja filtra		koda	BR540262				
		cena	111,90				
Stenski daljinski upravljalnik s prikazovalnikom, tedenski časovnik, pregled in upravljanje vseh funkcij naprave		koda	BR510498				
		cena	306,40				
Brink Home za standardno in plus verzijo		koda		BR510510			
		cena		411,40			
Tipalo vlage v kanalu		koda	BR310657				
		cena	241,20				
CO2 tipalo, priključitev na E-bus, za plus verzijo Renovent Excellent, Sky in vse verzije Flair		koda	BR532126				
		cena	493,00				
Dogrelnik za plus verzije, za obe verziji Flair (navadni in plus)		koda	BR310702	BR310730	BR310690	BR310692	BR310699
		* cena	344,40	464,40	548,00 €	548,00	652,20
Priključni Box (Plus verzija) za Flair 225/325/400, za priključitev dodatne opreme		koda	BR532700				
		cena	312,10				
Podstavek za napravo, velikost podstavka (V x G x Š) 400 x 520 x 668 mm <i>samo za 4/0</i>		koda	BR532990	BR217083	BR532708		BR532819
		* cena	153,30	194,70	228,80		259,60
Modbus modul		koda		BR532121			
		* cena		442,10			
Kpl. za nadzorovano prezračevanje na osnovi časovnika 2.0		koda	BR310431				
		* cena	871,60				
Sifon s krogličico *samo za naprave SKY *model Flair ima serijsko že vgrajen sifon s krogličico		koda	OHSIFON				
		cena	56,00				
Podometni sifon s krogličico *priporočamo za SKY		koda	OHSIFONPOD				
		cena	45,00				













DODATKI ZA PREZRAČEVALNE NAPRAVE BRINK RENOVENT, FLAIR

Naziv	Slika	koda	cena
Predgrelnik SKY 150		BR310683	443,90
Predgrelnik SKY 200		BR310640	443,90
Predgrelnik SKY 300		BR310681	443,90
Dogrelnik SKY 150		BR310730	464,40
Dogrelnik SKY 200		BR310630	464,40
Dogrelnik SKY 300		BR310671	464,40
Entalpijski izmenjevalnik Sky 150		BR532263	1.732,00
Entalpijski izmenjevalnik Sky 200			
Entalpijski izmenjevalnik Sky 300		BR532060	1.913,30 €

* element ni na zalogi, dobavljivo po naročilu, predhodno je potrebno preveriti rok dobave

ELEMENTI ZA IZVEDBO ZAJEMA SVEŽEGA IN ODPADNEGA ZRAKA

Naziv	Slika		Flair 225, Sky 150, Exc. 180 DN125	Flair 325, Sky 200/300 DN160	Flair 400 DN180	
Strešni izolirani odvodni/dovodni priključek		koda	BR648710	BR648600	BR648670	
		cena	157,50	230,80	237,20	
Izolirana strešna kapa, podaljšana pod streho, črna PP <i>*del kompleta*</i>		koda		UB169859	UB169860	
		cena		169,30	308,50	
Strešni okvir za kapo, univerzalna za nagib 25° - 45°, črn, 500x600mm <i>*del kompleta*</i>		koda		UB174132	UB174136	
		cena		163,20	296,40	
Stenski pritrdilni obroč <i>*del kompleta*</i>		koda		UB169075	UB169082	
		cena		8,40	8,90	
Pribor za zajem zraka skozi zid (izolirana cev z manšeto), dolžine 100 mm, v INOX izvedbi		koda		KO648730IN	KO648660IN	KO648690IN
		* cena		160,16	164,00	176,81
Pribor za zajem zraka skozi zid (izolirana cev z manšeto), barva RAL 9010 cev skrajšana na 100 mm		koda	KO648730	KO648660	KO648690	
		cena	102,50	106,34	120,68	
2 v 1 fasadni element INOX za zajem in izpust zraka		koda	KO2V1DN125INOX	KO2V1DN160INOX	KO2V1DN180INOX	
		* cena	230,63	256,25	281,88	
2 v 1 fasadni element iz poc. ploč, barva RAL 9010, za zajem in izpust zraka		koda	KO2V1DN125	KO2V1DN160	KO2V1DN180	
		cena	151,91	162,50	187,50	
Aerfoam - EPE koleno, izolirano 15°		koda	UB188260	UB188222	UB188280	
		cena	7,70	9,30	10,80	
Aerfoam - EPE koleno, izolirano 30°		koda	UB188261	UB188223	UB188281	
		cena	7,70	9,30	10,80	
Aerfoam - EPE koleno, izolirano 45°		koda	UB188262	UB188224	UB188282	
		cena	7,70	9,30	10,80	
Aerfoam - EPE koleno, izolirano 90°		koda	UB188263	UB188225	UB188283	
		cena	10,80	15,10	20,00	
Aerfoam - EPE cev, izolirana, L=2000 mm		koda	UB188202	UB188210	UB188206	
		cena	54,70	58,00	64,80	
Aerfoam EPE T-kos		koda	UB188264	UB188266	UB188267	
		cena	29,00	31,70	42,00	
Aerfoam - spojka za EPE cevi		koda	UB188265	UB188255	UB188285	
		cena	7,90	7,90	7,90	
Aerfoam - obešalo za EPE cevi		koda	UB169141			
		cena	5,30			
Aerfoam - obešalo za EPE cevi 160/180/200		koda				
		cena	UB169140 5,00			
Spojka iz pocinkane pločevine		koda	PRSK125	PRSK160	PRSK180	
		cena	3,30	3,50	3,70	
Element za predpripravo odprtine v AB plošči, DN 125 in DN 156		koda	PREBPEK125	PREBPEK160		
		* cena	15,50	17,50		
Reducirni kos DN 160-180		koda				
		cena				PRRED160/180 12,40

ELEMENTI ZA IZVEDBO ZAJEMA SVEŽEGA IN ODPADNEGA ZRAKA			
Naziv	Slika		Flair 450, 600, DN200
Strešni izolirani odvodni/dovodni priključek		koda	BR648770
		cena	238,41
Pribor za zajem zraka skozi zid (izolirana cev z manšeto), dolžine 100 mm, v INOX izvedbi		koda	KO648699IN
		* cena	205,00
Pribor za zajem zraka skozi zid (izolirana cev z manšeto), barva RAL 9010 cev skrajšana na 100 mm		koda	KO648699
		cena	113,00
2 v 1 fasadni element INOX za zajem in izpust zraka		koda	KO2V1DN200INOX
		* cena	339,00
2 v 1 fasadni element iz poc. ploč, barva RAL 9010, za zajem in izpust zraka		koda	KO2V1DN200
		cena	222,00
Aerfoam - EPE cev, izolirana, L=2000 mm		koda	UB188218
		cena	112,30
Aerfoam - EPE koleno, izolirano 15°		koda	UB188228
		cena	16,40 €
Aerfoam - EPE koleno, izolirano 30°		koda	UB188229
		cena	16,40
Aerfoam - EPE koleno, izolirano 45°		koda	UB188226
		cena	16,40
Aerfoam - EPE koleno, izolirano 90°		koda	UB188227
		cena	26,40
Aerfoam EPE T-kos (DN200)		koda	UB188268
		cena	46,50
Aerfoam - spojka za EPE cevi		koda	UB188268
		cena	8,80
Aerfoam - obešalo za EPE cevi 160/180/200		koda	UB169140
		cena	5,00
Spojka iz pocinkane pločevine		koda	PRSKFI200B
		cena	7,90
Reducirni kos DN 180-200		koda	PRRED180/200
		cena	13,00

* element ni na zalogi, dobavljivo po naročilu, predhodno je potrebno preveriti rok dobave

DUŠILNIKI ZVOKA					
Fleksibilni cevni dušilnik zvoka iz aluminija		koda	PRDZ125-180-1	PRDZ160-200-1	PRDZ180-250-1
		cena 1 m	75,60	79,60	104,08
		koda	PRDZ125-180-1,5	PRDZ160-200-1,5	PRDZ180-250-1,5
		cena 1,5 m	81,60	93,50	118,65
		koda	PRDZ200-250-1	PRDZ200-250-1,5M	
		cena 1 m	129,10		
		cena 1,5 m		165,28	

DODATKI NA PREZRAČEVALNEM SISTEMU - VLAŽENJE						
Naziv	Slika		DN125	DN160	DN180	DN200
Vlažilnik HomEvap (wi-fi)			HEPH			
Vlažilnik HomEvap (žični)		koda	HEPHW			
		cena	1.763,00			
Pomožni vlažilnik HomEvap (master&slave)		koda				HEPBH
		cena				1.192,00
Vlažilnik HomEvap z 35% več vlaženja (wi-fi)			HEPH15			
Vlažilnik HomEvap z 35% več vlaženja (žični)		koda	HEPHW15			
		cena	1.915,00			
Vlažilnik HomEvap 1500W (od 300-600 m3/h (wi-fi)					HEPH15600	
Vlažilnik HomEvap 1500W (od 300-600 m3/h (žični)		koda				HEPHW15600
		cena			1.971,00	
Nadomestni vložek "Legiosafe"		koda	HEPCAH			
		cena	460,00			
Nadomestno satje vložka "Legiosafe", komplet dveh vložkov		koda	HEMATB			
		cena	258,00			
Nadomestni vložek HomEvap "Cooler"		koda			HEPCAC	
		cena			332,00	
Nadomestno satje vložka "Cooler"		koda			HEMATK	
		cena			200,00	
LegioSafe komplet, z montažnim stojalom		koda			LS23FILEXT	
		cena			245,00	
LegioSafe nadomestna kartuša		koda			LS23CARTCOMP	
		cena			134,00	
Reducirni kos 125/200		koda	PRRED125/200			
		cena	9,80			
Reducirni kos 160/200		koda		PRRED160/200		
		cena		7,60		
Reducirni kos 180/200		koda			PRRED180/200	
		cena			13,00	
Spojni kos iz pocinkane pločevine fi 201/201 za HomEvap		koda				PRSK201EVAP
		cena				12,60
MEHČANJE VODE						
Reverzno osmozni čistilnik pitne vode		koda			VOM140RO030	
		* cena			373,94	
Montaža čistilnika pitne vode (reverzno osmosni)		koda			STMOOSMO	
		cena			150,00	
RO-5 set, filtrirni vložki + o-ringi		koda			M026RO7050	
		cena			125,92	
RO membrana TLC 75 gpd, membrana za		koda			M026RO5020	
		cena			103,68	
DODATKI NA PREZRAČEVALNEM SISTEMU – FILTRACIJA ZRAKA						
Naziv	Slika		Flair225 DN125	Flair 325 DN160	Flair 400 DN180	Sky 300 DN160
Pure induct - Modularni dodatek k prezračevanju za filtriranje zraka z uporabo ionizacije. Učinkovit proti: prahu, nano delcem, virusom, bakterijam in vonjavam.		koda				BR351000
		* cena				1.531,90
Filter Pure induct F7		koda				BR351003
		* cena				123,80
Filter Pure karbonski filter						BR351004
						87,00
Reducirni kos DN200 - DN160, potrebna 2 kos-a		koda	PRRED125/200	PRRED160/200	PRRED180/200	PRRED160/200
		cena	9,80	7,60	13,00	7,60

* element ni na zalogi, dobavljivo po naročilu, predhodno je potrebno preveriti rok dobave

DODATKI K PREZRAČEVALNEMU SISTEMU - Pohlajevanje in ogrevanje			
Naziv		koda	* Cena
COLD.W - vodni toplotni prenosnik		COLD.W	917,00
Termostat za COLD.W		COLD.W.TR	144,00
COLD.X.F.I - komplet (elektronika, termostat, zun. enota)		COLD.X.F.I	3.333,00
COLD.R.4 - zračni toplotni prenosnik (do 400m ³ /h)		COLD.R.4	1.127,00
COLD.R.4.F - zračni toplotni prenosnik (do 400m ³ /h) z možnostjo filtracije zraka (za uporabo pred rekuperatorjem)		COLD.R.4.F	1.210,00
Filter G4 za COLD.R.4.F		CL900023	10,00
COLD.R.6 - zračni toplotni prenosnik (do 600m ³ /h)		COLD.R.6	1.311,00
COLD.R.6.F - zračni toplotni prenosnik (do 600m ³ /h) z možnostjo filtracije zraka (za uporabo pred rekuperatorjem)		COLD.R.6.F	1.416,00
Filter G4 za COLD.R.6.F		CL900025	14,00
COLD.X.F.I			
			
COLD.W		COLD.R.4, COLD.R.6	
			
			
Material-izolacija dovoda sistema			
Naziv		koda	* Cena
Izolacija cevak ST 09 x 76		PRIZST09X76	5,20
Izolacija za adapterje in komore (ST10) - samolepilna		IZST10mm-1M2SAMO	19,40
Izolacijski samolepilni trak širine 10 cm, debeline 3 mm in dolžine 15 m		IZT100X3X15MST	45,90
Zagon sistema			
Zagon sistema COLD.X terminsko z zagonom prezračevanja		COLD.X.STZA	90,00
Zagon sistema COLD.X ločen termin		COLD.X.STZA2	140,00
Frigo montaža			
Hlajenje v kanalu COLD.X delo izoliranja (na meter)		COLDIZOLIRANJE	3,20
Frigo montaža sistema COLD.X (do 6 m)		COLD.X.MONT	440,00
Dodatna instalacija od 6m dalje 1/4-3/8mm (na meter)		MIDNIS	30,00
Linijski difuzorji			
Linijski difuzorji za vgradnji v spuščeni stop, z priključki DN 75		RLINE218625375	496,00
		RLINE2181250475	648,00
Razdelilne komore			
Razdelilna komora, zvočno in toplotno izolirana, z dušilno kuliso		naziv	10 x DN75 in 1 x DN 200
		koda	ACRK200-10X75+DK IZVRDKSS1075160
		cena	820,00
		naziv	14 x DN75 in 1 x DN 200
		koda	ACRK200-14X75+DK IZVRDKSS1475180
		cena	932,00
		naziv	17 x DN75 in 1 x DN 200
		koda	ACRK200-17X75+DK
		cena	951,00
		naziv	20 x DN75 in 1 x DN 200
		koda	ACRK200-20X75+DK IZVRDKSS2075200
		cena	1.039,00
			

DODATKI K PREZRAČEVALNEMU SISTEMU - Hlajenje in ogrevanje z obtokom			
Naziv		koda	* Cena
COLD.CX.I - komplet obtočni sisrem (COLD.CX, elektronika, termostat, zun. enota)		CL400002	4.643,00
COLD.X.F.I			
			
Material-izolacija dovoda sistema			
Izolacija cevak ST 09 x 89		6,40	PRIZST09X89
Izolacija za adapterje in komore (ST10) - samolepilna		19,40	IZST10mm-1M2SAMO
Izolacijski samolepilni trak širine 10 cm, debeline 3 mm in dolžine 15 m		45,90	IZT100X315MST
Zagon sistema			
Zagon sistema COLD.X terminsko z zagonom prezračevanja		90,00	COLD.X.STZA
Zagon sistema COLD.X ločen termin		140,00	COLD.X.STZA2
Frigo montaža			
Hlajenje v kanalu COLD.X delo izoliranja (na meter)		3,20	COLDIZOLIRANJE
Frigo montaža sistema COLD.X (do 6 m)		440,00	COLD.X.MONT
Dodatna instalacija od 6m dalje 1/4-3/8mm (na meter)		30,00	MIDNIS
Linijski difuzorji			
Linijski difuzorji za vgradnji v spuščeni stop, z priključki DN 75		RLINE218625290	521,00
		RLINE2181250390	663,00
Razdelilne komore			
Razdelilna komora, zvočno in toplotno izolirana, z dušilno kuliso		naziv	10 x DN75 in 1 x DN 200
		koda	ACRK200-10X90+DK
		cena	820,00
		naziv	14 x DN75 in 1 x DN 200
		koda	ACRK200-14X90+DK
		cena	932,00
		naziv	17 x DN75 in 1 x DN 200
		koda	ACRK200-17X90+DK
		cena	951,00
		naziv	20 x DN75 in 1 x DN 200
		koda	ACRK200-20X90+DK
		cena	1.135,00
			



Univerzalne komore serije 800

Univerzalne komore serije 800 so zasnovane po sistemu "ena za vse" in so dobavljive v treh različicah. Komora DB808 ima 8 priključkov, DB816 ima 16 priključkov, DB824 pa 24 priključkov za maksimalno svobodo izbire kombinacij pri montaži.

Priključek za dovod in odvod ima adapter za priključitev cevi dimenzij 125, 150, 160 in 180 mm. Cevi za dovod in odvod se lahko priključi vertikalno ali horizontalno. Serija 800 omogoča tudi vgraditev dodatka za dušenje zvoka, ki absorbira zvok, ki ga

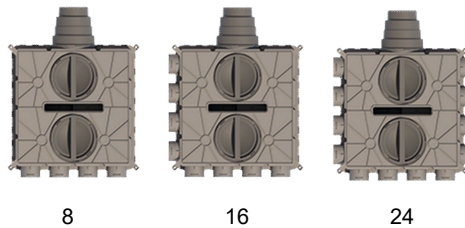
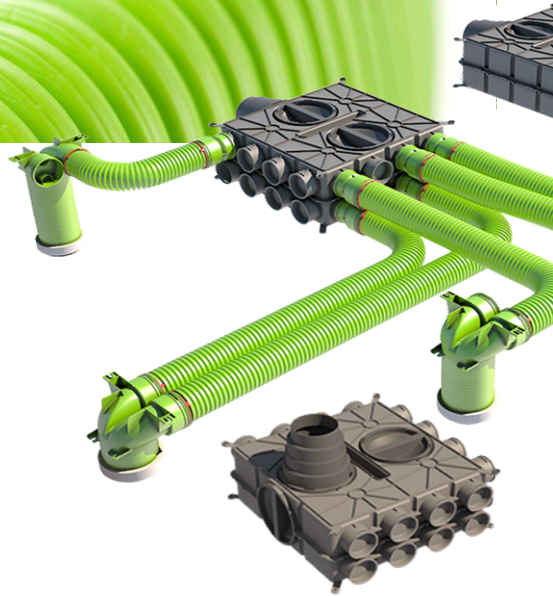

8

16

24

Distribucijske komore serije 200

Komore serije 200 so zasnovane modularno in jih je možno funkcionalno razdeliti, sestaviti, povezati, razstaviti in ponovno montirati glede na trenutne in bodoče potrebe in dimenzijske zahteve objekta. Sistem je sestavljen iz osnovne komore, podaljškov in adapterjev, ki jih lahko sestavimo v en sistem. To omogoča sestavo točno takšnega sistema, kot je potreben za dano situacijo na objektu. Majhna velikost sistema je idealna za vgradnjo v stanovanja ter objekte, ki so prostorsko omejeni. Pri montaži na tla, v steno ali na strop ne potrebujemo dodatnih nosilcev, izvede pa jo lahko ena sama oseba.



6 priključkov



8 priključkov



12 priključkov













16 priključkov



















12 priključkov

















KOMORE					
Naziv		Flair 325 DN160	Flair 400 DN180	Sky 150, Exc. 180, Flair 225 DN125	Sky 200/300 DN160
DBOX206, komora plastična 6 x DN75, priključek DN 125 ali 160 ali 180, 3x čep, 6x regulacijski element		koda	UB188960		
		št. priključkov	6		
		cena	156,30		
DBOX208, komora plastična 8 x DN75, priključek DN 125 ali 160 ali 180, 4x čep, 8x regulacijski element		koda	UB188961		
		št. priključkov	8		
		cena	156,00		
DBOX 212, komora plastična 12 x DN75, priključek Φ 125 ali 160 ali 180, 6x čep, 12x regulacijski element		koda	UB188964		
		št. priključkov	12		
		cena	234,10		
DBOX 212 INLINE, komora plastična 12 x DN75, priključek DN 125 ali 160 ali 180, 6x čep, 12x regulacijski element		koda	UB188967		
		št. priključkov	12		
		cena	234,10		
DBOX 216, komora plastična 16 x DN75, priključek DN 125 ali 160 ali 180, 8x čep, 16x regulacijski element		koda	UB188965		
		št. priključkov	16		
		cena	233,70		
DBOX 808, komora plastična 8 x DN75, priključek DN 125 ali 160 ali 180, 4x čep, 8x regulacijski element		koda	UB188950		
		št. priključkov	8		
		cena	299,60		
DBOX 816, komora plastična 16 x DN75, priključek DN 125 ali 160 ali 180, 8x čep, 16x regulacijski element		koda	UB188951		
		št. priključkov	16		
		cena	304,70		
DBOX 824, komora plastična 24 x DN75, priključek DN 125 ali 160 ali 180, 20x čep, 20x regulacijski element		koda	UB188952		
		št. priključkov	24		
		cena	327,60		
Reducirni kos DN 125-160-180		koda	UB188970		
		cena	19,70		
Reducirni kos DN 100-125 za DBOX komoro		koda	UB188637		
		cena	21,60		
Priključni kit za komoro DBOX 206, DN125		koda	UB188977		
		cena	24,80		
Regulacijski element pretoka zraka za DBOX komore (10 kos v kompletu)		koda	UB188564		
		cena/kpl	8,90		
Kulise za dušenje zvoka za DBOX plastično komoro		koda	UB188039		
		cena/kpl	38,20		
Čep za plastično DBOX komoro (10 kos v kompletu)		koda	UB188563		
		cena/kpl	11,20		

* element ni na zalogi, dobavljivo po naročilu, predhodno je potrebno preveriti rok dobave

AIR EXCELLENT - SISTEM ZA RAZVOD PO PROSTORIH - dim. DN 75 (AE34c)













Naziv - opis	Slika		dim. cevi DN75
Cev za prezračevanje - antistatična & antibakterijska (prodaja kolut po 50 m)		koda cena/m	UB188661 5,40
Pokrov cevi (10 kos v kompletu)		koda cena/kpl	UB188681 19,20
Podaljševalna cevna spojka - konektor		koda cena/kos	UB188350 6,70
Tesnilni obroč DN75/63 mm (10 kos v kompletu)		koda cena/kpl	UB188348 18,60
Tesnilni obroč DN75/63 (10 kos v kompletu)		koda cena/kpl	UB188391 12,80
Tesnilni obroč z tesnilom DN75/63 (10 kos v kompletu)		koda cena/kpl	UB188991 31,00
Koleno za cev DN75 90°		koda cena/kos	UB188173 7,60
Vertikalno koleno - okroglo/ovalno		koda cena/kos	UB188343 17,40
Ravni adapter za prezračevalni ventil 2x75, DN125		koda cena/kos	UB188399 39,70
Kotni adapter za prezračevalni ventil 2x75, DN125		koda cena/kos	UB188342 38,50
Adapter za prezračevalni ventil 1x75, DN125		koda * cena/kos	UB188185 34,60
Adapter za talno rešetko 2x75		koda * cena/kos	UB188397 36,60
Kanalska objemka (univerzalna - 10 kos v kompletu)		koda cena/kpl	UB188396 32,60
Regulacijska loputa		koda * cena/kos	UB188663 18,50
Križni element		koda cena/kpl	UB188199 37,60
Fleksibilni cevni dušilnik zvoka iz aluminija		koda cena 0,5 m	PRDZ80-125-0,5 58,80
		koda cena 1 m	PRDZ80-125-1 66,00
		koda cena 1,5 m	PRDZ80-125-1,5 73,20
Nož za rezanje zelene cevi DN75		koda cena	UB188691 13,51

AIR EXCELLENT - SISTEM ZA RAZVOD PO PROSTORIH - dim. 102 x 50 mm (AE23sc)

Naziv - opis	Slika	dim. cevi 102 x 50 mm	
Cev za prezračevanje - antistatična & antibakterijska		koda * cena/kos	UB188299 10,30
Pokrov cevi (10 kos v kompletu)		koda * cena/kos	UB188677 18,10
Zaključni pokrov		koda * cena/kos	UB188305 3,00
Podaljševalna cevna spojka - konektor		koda * cena/kos	UB188306 11,30
Spojka med priključkom in cevjo		koda * cena/kos	UB188302 4,90
Koleno vertikalno 90°		koda * cena/kos	UB188303 14,00
Koleno horizontalno 90°		koda * cena/kos	UB188304 14,00
Kanalska objemka (univerzalna - 10 kos v kompletu)		koda * cena/kos	UB188396 32,60
Priključek za komoro okroglo/ovalni		koda * cena/kos	UB188554 5,50
Vertikalno koleno - okroglo/ovalno		koda * cena/kos	UB188343 17,40
Adapter za prezračevalni ventil 1x dim. 102x50 DN125		koda * cena/kos	UB188184 38,20
Kotni adapter za prezračevalni ventil 2x dim. 102x50, DN125		koda * cena/kos	UB188300 35,00
Adapter za talno rešetko 2x dim. 102 x 50		koda * cena/kos	UB188308 35,49
Ravni adapter za prezračevalni ventil 2 x dim. 102 x 50, DN125		koda * cena/kos	UB188310 45,30

* element ni na zalogi, dobavljivo po naročilu, predhodno je potrebno preveriti rok dobave









AIR EXCELLENT - SISTEM ZA RAZVOD PO PROSTORIH - dim. DN 90 (AE48c)

Naziv - opis	Slika		dim. cevi DN90
Cev za prezračevanje - antistatična & antibakterijska (prodaja kolut po 50 m)		koda * cena/kos	UB188662 7,10
Pokrov cevi (10 kos v kompletu)		koda * cena/kos	UB188676 27,80
Zaključni pokrov		koda * cena/kos	UB188381 4,40
Podaljševalna cevna spojka - konektor		koda * cena/kos	UB188365 9,80
Tesnilni obroč DN 90/75 mm (10 kos v kompletu)		koda * cena/kos	UB188366 21,20
Spojka na klik DN 90/75 mm (10 kos v kompletu)		koda * cena/kos	UB188392 14,00
Kanalska objemka (univerzalna - 10 kos v kompletu)		koda * cena/kos	UB188396 32,60
Koleno za cev dim. DN 90 - 90°		koda * cena/kos	UB188174 18,80
Prehodni kos z dimenzije DN 90 na 130 x 60		koda * cena/kos	UB188585 20,80
Kotni adapter za prezračevalni ventil 1x90, DN125		koda * cena/kos	UB188188 36,00
Kotni adapter za prezračevalni ventil 2x90, DN125		koda * cena/kos	UB188380 39,40
Adapter za DBOX - CEV		koda * cena/kos	UB188553 5,40
Fleksibilni cevni dušilnik zvoka iz aluminija		koda * cena 0,5 m	PRDZ100-150-0,5 68,40
		koda * cena 1 m	PRDZ100-150-1 68,40
		koda * cena 1,5 m	PRDZ100-150-1,5 74,40

* element ni na zalogi, dobavljivo po naročilu, predhodno je potrebno preveriti rok dobave

DISTRIBUCIJSKI ELEMENTI



VENTILI, REŠETKE

Naziv	Slika		Ident Cena
Ventil prezračevalni DOVODNI DN125		koda cena	UB188050 13,80
Ventil prezračevalni ODVODNI DN125		koda cena	UB188049 13,80
Dovodno-odvodni prezračevalni ventil tip Haelix Rondo, dim. 125, barve RAL9016		koda cena	UB188060 47,00
Dovodno-odvodni prezračevalni ventil tip Haelix Quadro, dim. 125, barve RAL9016		koda cena	UB188061 47,00
Kuhinjska rešetka s filtrom dimenzije maske (ŠxVxG): 220x220x30 mm		koda cena	BR925080 134,60
Kuhinjska rešetka s filtrom - vgradna (knauf) dimenzije maske: (ŠxVxG): 250x250x5 mm potrebna odprtina: 225 x 225 mm		koda cena	BR925080Z 202,60
Ventil prezračevalni tip Borea za odvod ali dovod zraka stenska ali stropna montaža DN125		koda cena	SYS00125 28,30
Talna prezračevalna rešetka, inox		koda * cena/kos	UB188317 77,80
Talna prezračevalna rešetka, barve RAL9010		koda * cena/kos	UB188316 85,90

* element ni na zalogi, dobavljivo po naročilu, predhodno je potrebno preveriti rok dobave

VENTMANN DIFUZORJI



Naziv	Slika	Koda	Cena
Okrogli difuzorji			
Okrogli, priklon 125 mm		VMCIRCLE125	55,00
Kvadratni difuzorji			
Kvadratni, priklon 125 mm		VMSQUARE125	62,50

Linijski difuzor "Line"		* Cena	
Dolžine 625 mm, enojna reža širine 12 mm		VMLINE625112	104,00
Dolžine 1000 mm, enojna reža širine 12 mm		VMLINE1000112	111,60
Dolžine 1250 mm, enojna reža širine 12 mm		VMLINE1250112	133,30
Dolžine 625 mm, enojna reža širine 18 mm		VMLINE625118	104,00
Dolžine 1000 mm, enojna reža širine 18 mm		VMLINE1000118	111,60
Dolžine 1250 mm, enojna reža širine 18 mm		VMLINE1250118	133,30
Dolžine 625 mm, dvojna reža širine 12 mm		VMLINE625212	133,30
Dolžine 1000 mm, dvojna reža širine 12 mm		VMLINE1000212	143,50
Dolžine 1250 mm, dvojna reža širine 12 mm		VMLINE1250212	153,80
Dolžine 625 mm, dvojna reža širine 18 mm		VMLINE625218	133,30
Dolžine 1000 mm, dvojna reža širine 18 mm		VMLINE1000218	143,50
Dolžine 1250 mm, dvojna reža širine 18 mm		VMLINE1250218	153,80
Dolžine 625 mm, trojna reža širine 12 mm		VMLINE625312	164,00
Dolžine 1000 mm, trojna reža širine 12 mm		VMLINE1000312	177,40
Dolžine 1250 mm, trojna reža širine 12 mm		VMLINE1250312	192,70
Dolžine 625 mm, trojna reža širine 18 mm		VMLINE625318	164,00
Dolžine 1000 mm, trojna reža širine 18 mm		VMLINE1000318	177,40
Dolžine 1250 mm, trojna reža širine 18 mm		VMLINE1250318	192,70

* element ni na zalogi, dobavljivo po naročilu, predhodno je potrebno preveriti rok dobave

VENTMANN DIFUZORJI

Priključni difuzorji		* Cena	
L-625 mm, za 1 do 2 reži, za velikost cevi 75 mm		VMGTG75625	100,00
L-1000 mm, za 1 do 2 reži, za velikost cevi 75 mm		VMGTG751000	105,00
L-1250 mm, za 1 do 2 reži, za velikost cevi 75 mm		VMGTG751250	115,00
L-625 mm, za 1 do 2 reži, za velikost cevi 125 mm		VMGTG125625	107,50
L-1000 mm, za 1 do 2 reži, za velikost cevi 125 mm		VMGTG1251000	115,00
L-1250 mm, za 1 do 2 reži, za velikost cevi 125 mm		VMGTG1251250	120,00
L-625 mm, za 1 do 2 reži, za velikost cevi 160 mm		VMGTG160625	115,00
L-625 mm, za 1 do 2 reži, za velikost cevi 160 mm		VMGTG1601000	130,00
L-625 mm, za 1 do 2 reži, za velikost cevi 160 mm		VMGTG1601250	127,50
L-625 mm, za 3 reže, za velikost cevi 125 mm		VMGTG3125625	107,50
L-1000 mm, za 3 reže, za velikost cevi 125 mm		VMGTG31251000	115,00
L-1250 mm, za 3 reže, za velikost cevi 125 mm		VMGTG31251250	120,00
L-625 mm, za 3 reže, za velikost cevi 160 mm		VMGTG3160625	115,00
L-1000 mm, za 3 reže, za velikost cevi 160 mm		VMGTG31601000	120,00
L-1250 mm, za 3 reže, za velikost cevi 160 mm		VMGTG31601250	132,50

		* Cena	
Spojka za cevi fi 75 za difuzor Ventmann		VMLINE75SPOJKA	7,00
Spojka za cevi fi 90 za difuzor Ventmann		VMLINE90SPOJKA	9,00

* element ni na zalogi, dobavljivo po naročilu, predhodno je potrebno preveriti rok dobave

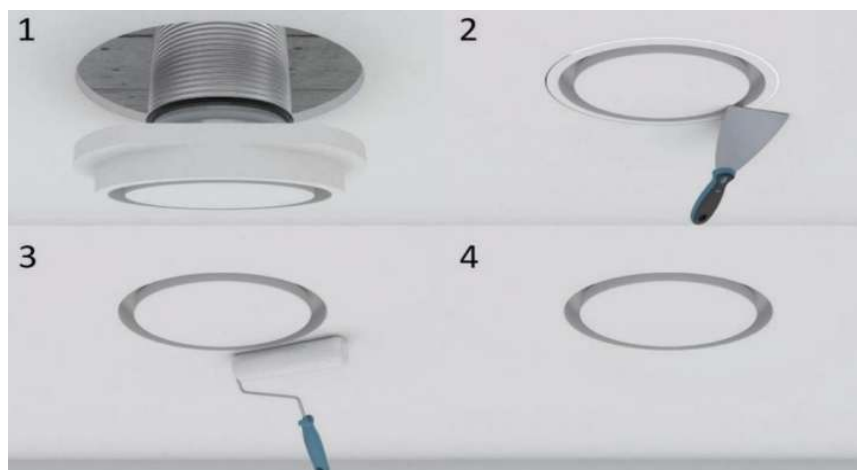

Prednosti mavčnih difuzorjev Ventmann so očitne

Inovativnost – prvi na trgu iz posebnega mavčnega kompozita.

Moderna oblika – njihov proizvodni proces je prilagodljiv in okolju prijazen, možnosti vgradnje pa skoraj neomejene.

Eleganca – pomagajo ohraniti celovitost notranje opreme in se popolnoma zlijejo s stenskim in stropnim površinami.

Lažje pleskanje – ker so difuzorji nameščeni skupaj s stropom ali stenami, jih je mogoče prebarvati z isto barvo.

Noben izmed mavčnih difuzorjev Ventmann ne ustvari okvirja na površini, na katero je nameščen. Ta učinek dosežemo tako, da jih pri vgradnji izravnamo s stropom ali steno.